

SKF TKED 1



Instructions for use
Mode d'emploi
Bedienungsanleitung
Instrucciones de uso

Manuale d'istruzioni
Instruções de uso
使用说明书
Инструкция по эксплуатации

EC Declaration of conformity

We, SKF Maintenance Products, Kelvinbaan 16, 3439 MT Nieuwegein, The Netherlands, declare that the

SKF TKED 1

has been designed and manufactured in accordance with: EMC DIRECTIVE 2004/108/EC as outlined in the harmonized norm for

EN 61326 - 1:2006
EN 61000 - 6-3:2007
EN 61000 - 4-2
EN 61000 - 4-3*
EN 61000 - 4-8

*with the exception of the electromagnetic field immunity in the frequency range of 80 MHz to 300 MHz at 2.5 V/m, where the instrument is sensitive to the electromagnetic field.

EUROPEAN ROHS DIRECTIVE 2011/65/EU

The Netherlands, 06 October 2008



A blue ink handwritten signature of Sébastien David.

Sébastien David
Manager Product Development and Quality

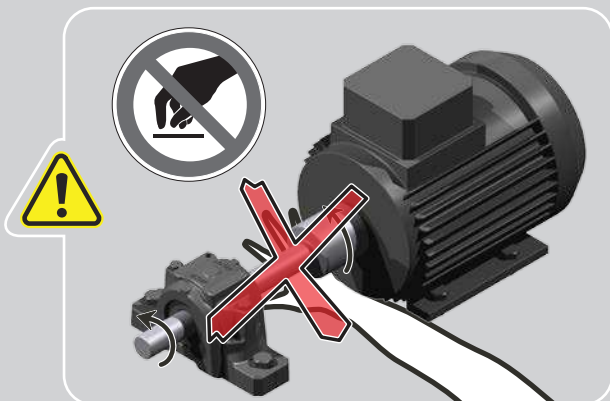



TKED 1
MP5355

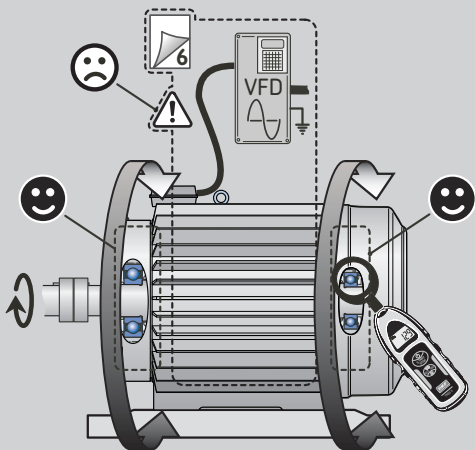
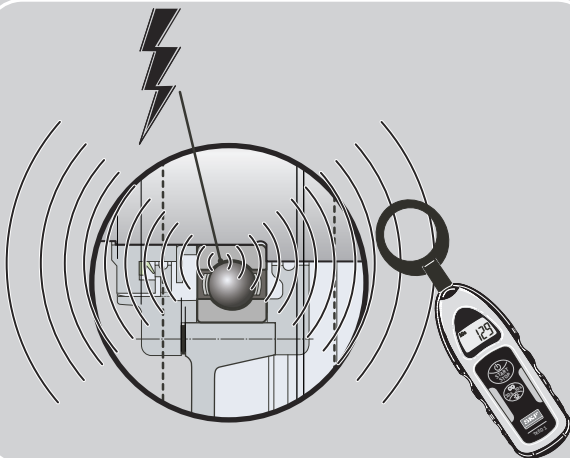

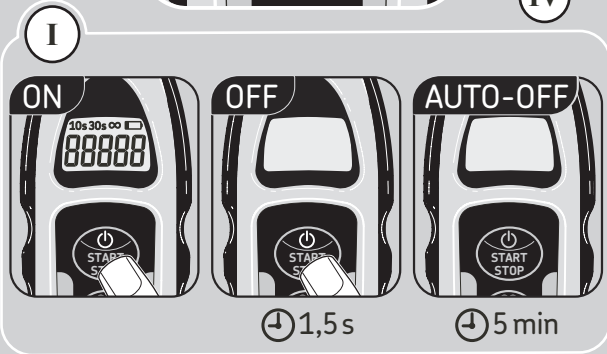
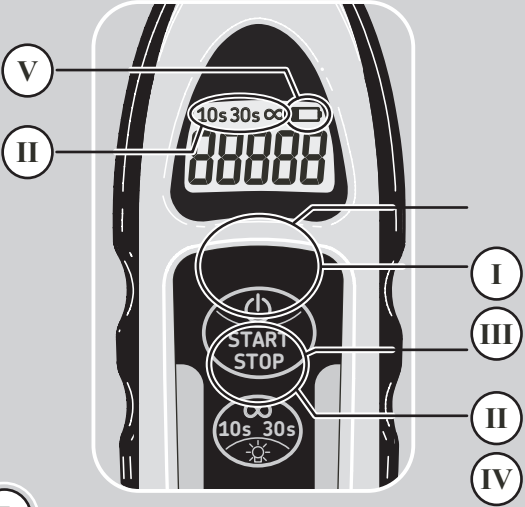
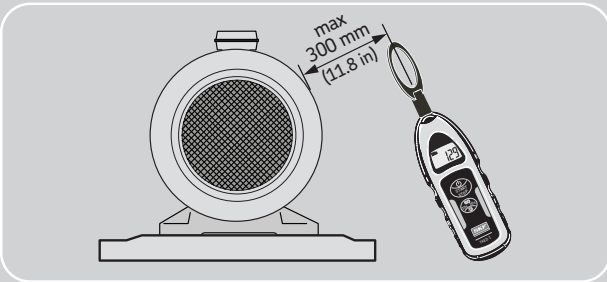

II



III

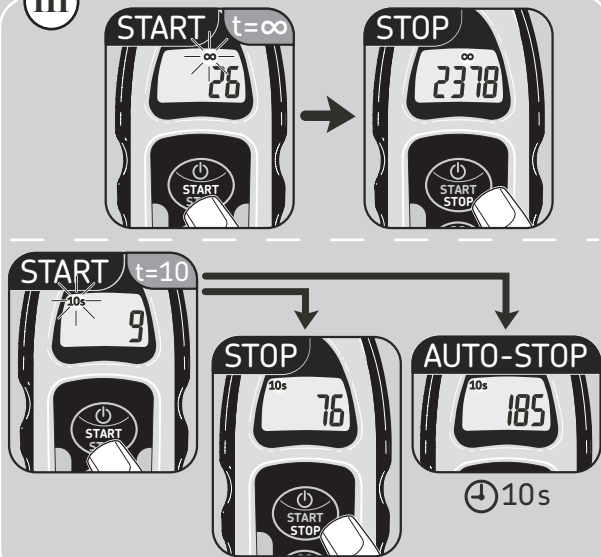

III

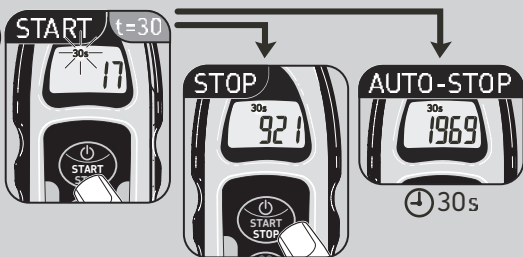

IV

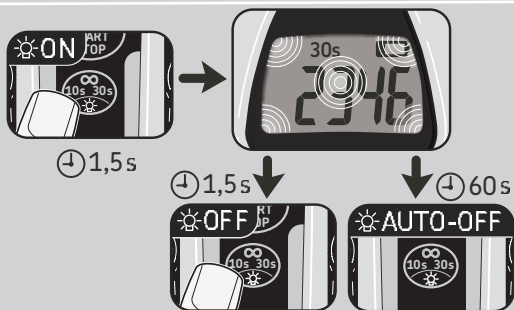

V

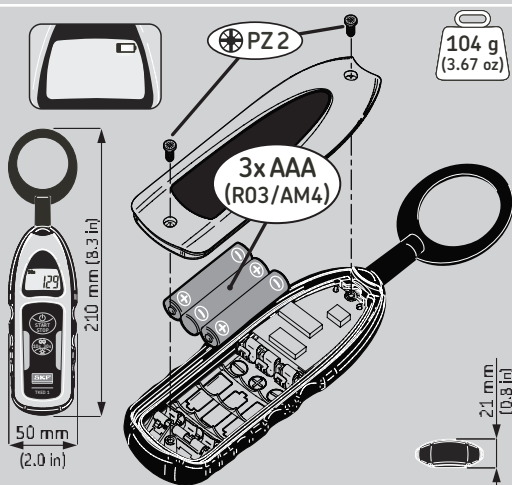

English



N.B.: Anywhere in the vicinity of a running or standstill motor, the internal reactive current may be detected by the SKF TKED 1.

Français



NB: Tout autour d'un moteur en fonctionnement ou à l'arrêt, le courant réactif interne peut éventuellement être détecté par le SKF TKED 1.

Deutsch



N.B.: Überall in der Umgebung eines laufenden oder eines nicht laufenden Motors kann dessen interner Blindstrom ebenfalls durch den SKF TKED 1 gemessen werden.

Español



Nota: En las proximidades de un motor parado o en funcionamiento, el SKF TKED 1 también puede detectar su corriente reactiva interna.

Italiano



N.B.: Vicino a un motore fermo o in funzionamento, il TKED 1 SKF può rilevare la sua corrente reattiva interna.

Svenska



Notera: Överallt i närheten av en motor, i drift eller stillestånd, kan även dess reaktiva ström bli detekterad av SKF TKED 1.

Nederlands



N.B.: Overal in de omgeving van een lopende of niet lopende motor kan de SKF TKED 1 eveneens de interne reactieve stroom meten.

Português



OBS.: Em qualquer lugar próximo de um Motor parado ou em funcionamento, a corrente reativa interna pode ser detectada pelo TKED 1 da SKF.

中文



注意：无论从什么地方接近运行中的或者是静止的电机，其内部的无功电流也可能被 SKF TKED 1 检测出来。

Русский



Прим.: В непосредственной близости от работающего или остановленного оборудования устройство SKF TKED 1 может определить наличие реактивного тока.

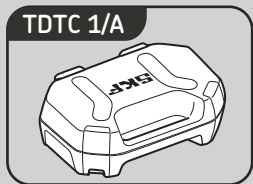
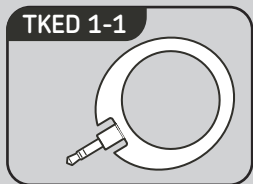
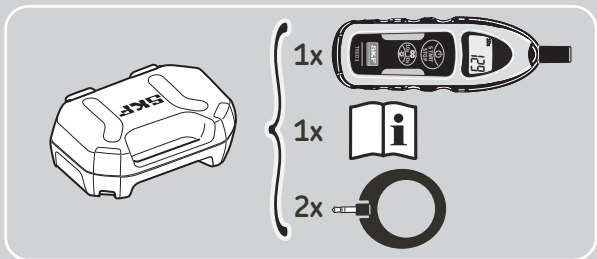
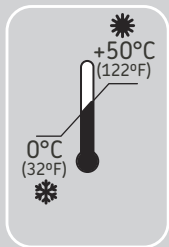
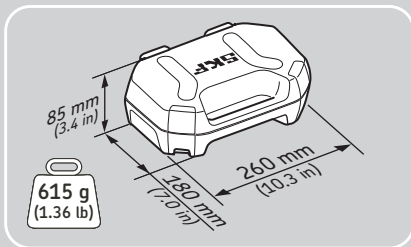
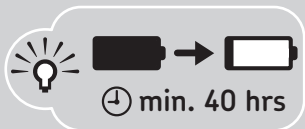

The contents of this publication are the copyright of the publisher and may not be reproduced (even extracts) unless prior written permission is granted. Every care has been taken to ensure the accuracy of the information contained in this publication but no liability can be accepted for any loss or damage whether direct, indirect or consequential arising out of the use of the information contained herein.

Le contenu de cette publication est soumis au copyright de l'éditeur et sa reproduction, même partielle, est interdite sans autorisation écrite préalable. Le plus grand soin a été apporté à l'exactitude des informations données dans cette publication mais SKF décline toute responsabilité pour les pertes ou dommages directs ou indirects découlant de l'utilisation du contenu du présent document.

Nachdruck, auch auszugsweise, nur mit unserer vorherigen schriftlichen Genehmigung gestattet. Die Angaben in dieser Druckschrift wurden mit größter Sorgfalt auf ihre Richtigkeit hin überprüft. Trotzdem kann keine Haftung für Verluste oder Schäden irgendwelcher Art übernommen werden, die sich mittelbar oder unmittelbar aus der Verwendung der hier enthaltenen Informationen ergeben.

El contenido de esta publicación es propiedad de los editores y no puede reproducirse (incluso parcialmente) sin autorización previa por escrito. Se ha tenido el máximo cuidado para garantizar la exactitud de la información contenida en esta publicación, pero no se acepta ninguna responsabilidad por pérdidas o daños, ya sean directos, indirectos o consecuentes, que se produzcan como resultado del uso de dicha información.

La riproduzione, anche parziale, del contenuto di questa pubblicazione è consentita soltanto previa autorizzazione scritta della SKF. Nella stesura è stata dedicata la massima attenzione al fine di assicurare l'accuratezza dei dati, tuttavia non si possono accettare responsabilità per eventuali errori od omissioni, nonché per danni o perdite diretti o indiretti derivanti dall'uso delle informazioni qui contenute.

O conteúdo desta publicação é de direito autoral do editor e não pode ser reproduzido (nem mesmo parcialmente), a não ser com permissão prévia por escrito. Todo cuidado foi tomado para assegurar a precisão das informações contidas nesta publicação, mas nenhuma responsabilidade pode ser aceita por qualquer perda ou dano, seja direto, indireto ou consequente como resultado do uso das informações aqui contidas.

本出版物内容的著作权归出版者所有且未经事先书面许可不得被复制（甚至引用）。我们已采取了一切注意措施以确定本出版物包含的信息准确无误，但我们不对因使用此等信息而产生的任何损失或损害承担任何责任，不论此等责任是直接、间接或附随性的。

Содержание этой публикации является собственностью издателя и не может быть воспроизведено (даже частично) без предварительного письменного разрешения. Несмотря на то, что были приняты все меры по обеспечению точности информации, содержащейся в настоящем издании, издатель не несет ответственности за любой ущерб, прямой или косвенный, вытекающий из использования вышеуказанной информации.



skf.com | mapro.skf.com | skf.com/mount

® SKF is a registered trademark of the SKF Group.

© SKF Group 2017

MP5355 · 2017/06